

PLAN VIEW

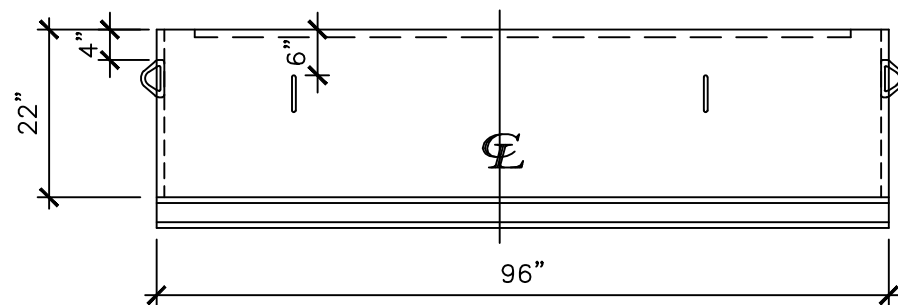

FRONT VIEW

Mark	Qty	Description
A	1	2" Weld Flange (Drain)
B	6	Lifting Lug
C	2	W4 x 13# x 96"

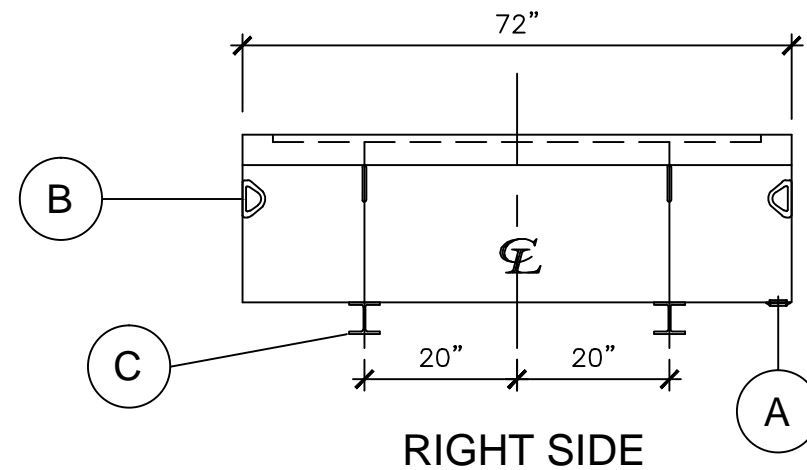

RIGHT SIDE

NOTES:

- A. Quantity: One
- B. Material: H.R. Carbon Steel.
- C. Exterior: One coat gray primer.

FOR APPROVAL

APPROVAL FOR CONSTRUCTION
PLEASE SIGN AND RETURN:

- APPROVED AS DRAWN.
- APPROVED WITH NOTED CHANGES,
CONSTRUCTION WILL BE SCHEDULED
WHEN SIGNED DRAWING AND
CONFIRMED ORDER ARE RECEIVED.

SIGNATURE _____
DATE: _____

SALES ORDER#



Phone: 870-735-4473 Fax: 870-735-3982

VESSEL DESCRIPTION:

Containment Dike For 550 Gallon Tank

CUSTOMER:

P.O.#

DATE:

SCALE:

DWG.#

NB00550CNT072022

DRAWN BY: TC

CHKD. BY: